



**TH 625**  
Telehandler



**Telehandler TH625**

Fully operational even with low overhead clearance. The performance, design and dimensions of the compact telehandler TH625 are perfectly suited for work in municipalities, factories, construction yards and building sites. The robustly built Wacker Neuson compact telehandlers of the 2x2 meter class have an ideal power-to-weight ratio. With their low fuel consumption and low maintenance and servicing requirements, they are an all-round economical choice.

- A robust, twist-resistant frame and compact dimensions with a height and width of less than 2 m
- Operator assistance system "vertical lift system" prevents overloading
- Performance kinematics with 150° swivel angle
- Powerful hydraulics with precise and sensitive joystick control
- High ground clearance for a wide range of applications



## Technical specifications

### Operating data

Weight without attachments	4,730 kg
Turning radius Tires	3,670 mm
Total rotation angle of the tool carrier	150 °

### Engine / Motor

Engine / Motor manufacturer	Deutz
Engine performance at 2800 rpm	50 kW

### Power transmission

Traction drive	hydrostatic
Speed	20 km/h
Speed optional	30 km/h
Differential lock	100% in the front axle (optional)
Service brake / parking brake	Rear axle disc brake
Standard tires	12.5-18

### Steering and operating hydraulics

Steering angle max.	2x 38 °
Flow rate	89 l/min

### Kinematics

Payload max.	2,500 kg
Lift height max.	5,730 mm
Payload at max. lifting height	1,800 kg
Payload at max. reach	800 kg
Range max. (stack)	3,156 mm

## Dimensions

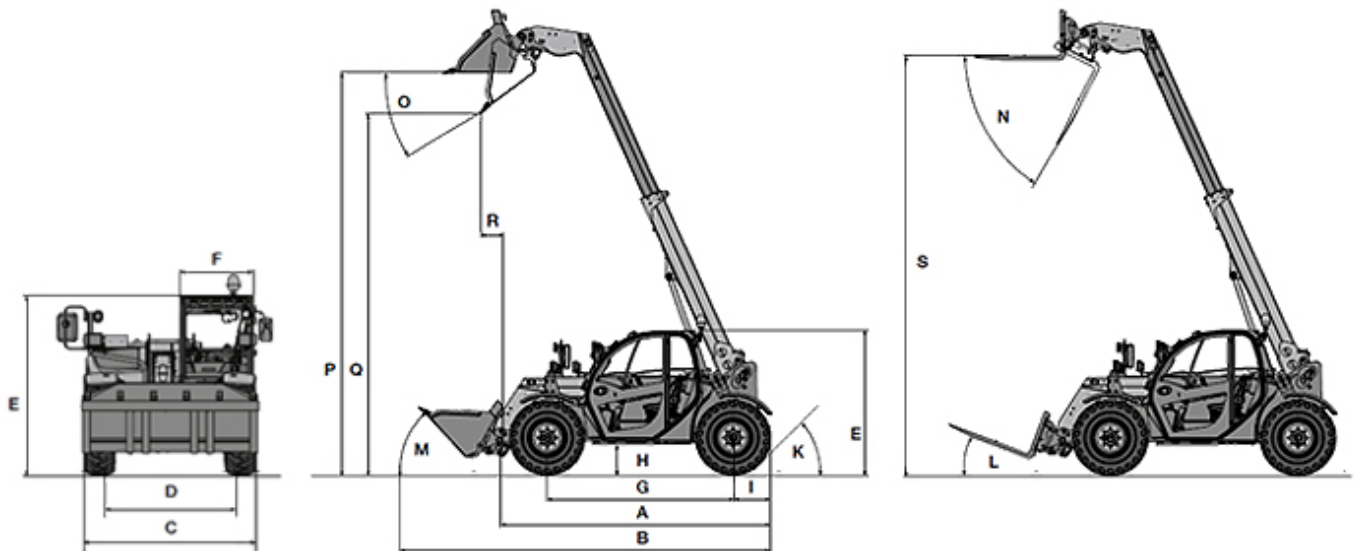

A	Length incl. tool frame	4,300 mm
B	Length with standard bucket *	4,958 mm
C	Width max.	1,960 mm
D	Track width	1,660 mm
E	Height to cab roof	1,980 mm
F	Width cab (interior)	825 mm
G	Wheelbase	2,650 mm
H	Ground clearance	302 mm
I	Center of rear axle to end of vehicle	620 mm
K	Rear actuation angle	80 °
L	Tilt-in angle pallet fork lowered	21 °
M	Tilt-in angle standard bucket lowered	45 °
N	Tip-out angle pallet fork raised	63 °



O	Tip-out angle standard bucket raised	40 °
P	Overhead loading height	5,600 mm
Q	Dumping height	5,280 mm
R	Dump reach	680 mm
S	Stack height	5,730 mm

\* incl. teeth We reserve the right to make modifications without prior notice. No responsibility is taken for the accuracy of this information. The provisions of the contractual agreement shall be considered definitive.

**Please note**

that product availability can vary from country to country. It is possible that information / products may not be available in your country. More detailed information on engine power can be found in the operator's manual; the stated power may vary due to specific operating conditions. Subject to alterations and errors excepted. Applicable also to illustrations.  
Copyright © 2015 Wacker Neuson SE.